

Tubular Screw Conveyors

Rohrschnecken

Vis sans fin tubulaires

Coclee tubolari

TU



Available from:

FILQUIP Pty Limited

5/126 Compton Rd, Underwood,
Qld 4119 Australia

Ph: +61 7 3208 3499 Fx: +61 7 3208 3449

Email: sales@filquip.com.au

www.filquip.com.au



WAM[®]

TU Tubular Screws consist of:

- External tube with fully welded inlet and outlet (selection of angles)
- Helicoid flighting welded onto an internal rotating pipe
- Two end bearing assemblies incorporating bearings fitted with long life seals
- Where needed intermediate hanger bearings

TU - Rohrschnecken bestehen aus folgenden Komponenten:

- Außenrohrmantel mit End- und Zwischenflanschen
- Endloswendeln auf Innenrohr verschweißt
- Endlagereinheiten mit langlebigen Abdichtungen
- Zwischenlager, sofern erforderlich

Les transporteur a vis de la série TU sont constitués de:

- Un tube extérieur fixe
- Une spire continue soudée sur un tube intérieur tournant
- Deux paliers d'extrémité avec presse-étoupe longue durée
- Éventuellement un ou plusieurs paliers intermédiaires

I trasportatori a coclea serie TU sono costituiti da:

- Un tubo esterno fisso
- Una spira continua saldata su un tubo interno ruotante
- Due testate dotate di tenute a lunga durata
- Eventuali supporti intermedi

Drive options:

- Bare shaft
- Direct drive
- Direct drive with flexible coupling
- With chain transmission

Antriebsoptionen:

- Ohne Antrieb mit freiem Wellenzapfen
- Mit Direktantrieb
- Mit Direktantrieb über Kupplung
- Mit Kettentrieb

Options de motorisations:

- Arbre nu
- Motorisation en ligne
- Motorisation flasquée avec accouplement
- Motorisation déportée avec entraînement par pignon et chaîne

Opzioni motorizzazioni:

- Ad albero nudo
- Con trasmissione diretta
- A trasmissione con giunto
- Con trasmissione a catena

Other options:

- Special seals
- Special end bearings
- Special flights
- Special intermediate bearings
- Variable speed drive

Optionen:

- Spezialabdichtungen für Endlagereinheiten
- Endlager in Sonderausführung
- Schneckenwendeln in Sonderausführung
- Regelantrieb

Sur demande:

- Étanchéités spéciales
- Paliers d'extrémité spéciaux
- Paliers intermédiaires spéciaux
- Spires spéciales
- Motovariateurs

A richiesta:

- Tenute speciali
- Testate speciali
- Supporti intermedi speciali
- Spire speciali
- Motovariatori





Bare Shaft
 Ohne Antrieb
 Arbore nu
 Albero nudo

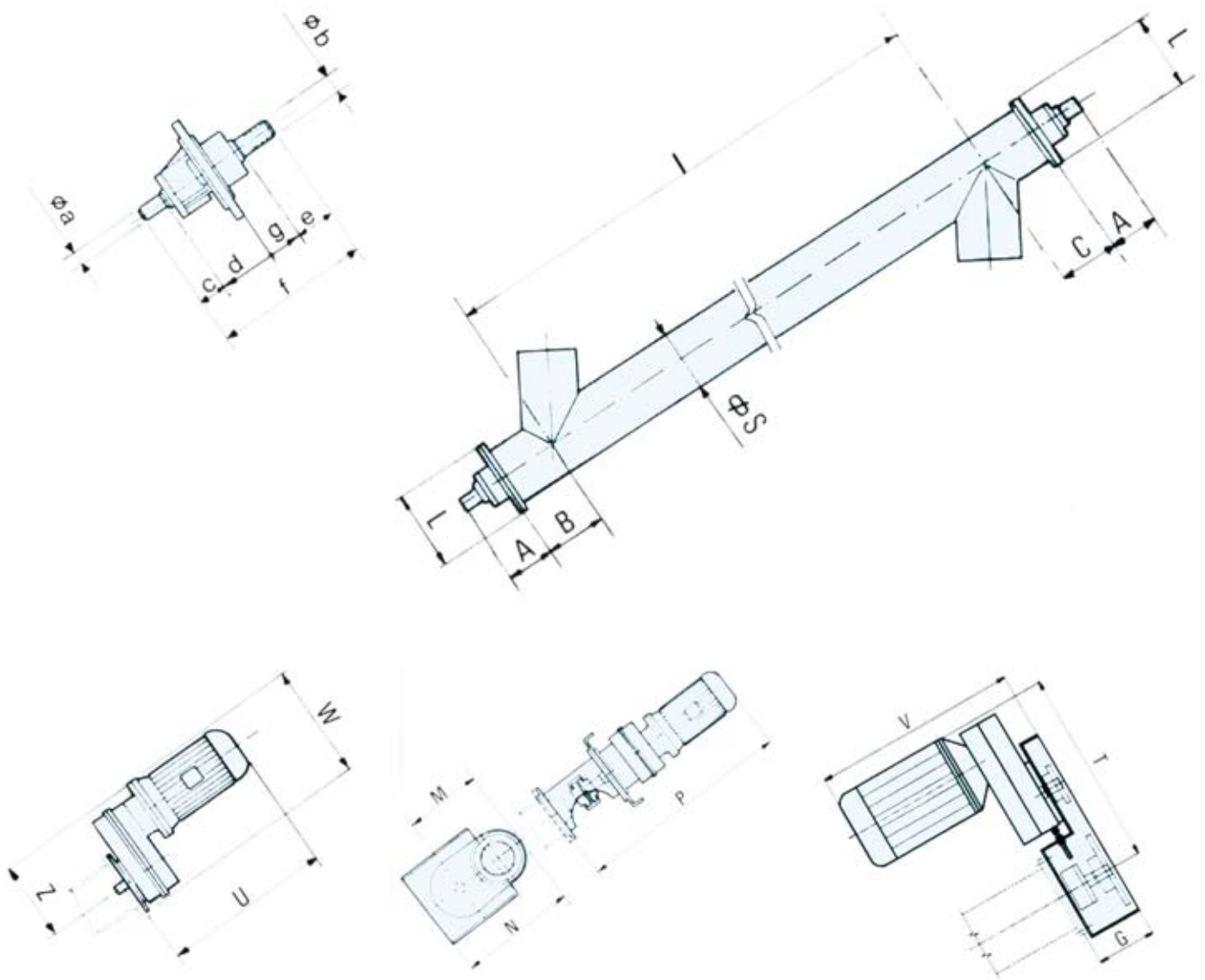

Direct Drive
 Direktantrieb
 Entraînement directe
 Trasmissione diretta

Flexible Coupling
 Direktantrieb über Kupplung
 Entraînement par accouplement
 Trasmissione con giunto

Chain Transmission
 Antrieb über Kettentrieb
 Entraînement par chaîne
 Trasmissione a catena

| Ø SCREW SCHNECKE VIS COCCLEA | A | B** | C** | G | I | L | M | N | P | S | T | U | V | W | Z | a | b DIN 5482 | c | d | e | f | g |
|--|-------|-----|-----|-----|---|-----|-----|-----|------|-----|-----|-----|-----|-----|-----|----|------------------|----|-------|----|-----|------|
| 114 | 131.0 | 140 | 120 | 150 | | 190 | 268 | 413 | 790 | 114 | 600 | 559 | 600 | 368 | 268 | 25 | 28 x 25 | 50 | 81.0 | 65 | 250 | 54.0 |
| 139 | 131.0 | 140 | 120 | 150 | | 190 | 268 | 413 | 790 | 139 | 600 | 559 | 600 | 368 | 268 | 25 | 28 x 25 | 50 | 81.0 | 65 | 250 | 54.0 |
| 168 | 172.5 | 160 | 140 | 190 | | 250 | 330 | 450 | 890 | 168 | 650 | 581 | 650 | 420 | 305 | 35 | 40 x 36 | 55 | 117.5 | 85 | 330 | 72.5 |
| 193 | 172.5 | 170 | 150 | 200 | * | 280 | 376 | 450 | 890 | 193 | 775 | 581 | 760 | 420 | 305 | 35 | 40 x 36 | 55 | 117.5 | 85 | 330 | 72.5 |
| 219 | 172.5 | 180 | 160 | 200 | | 275 | 400 | 490 | 890 | 219 | 775 | 581 | 760 | 420 | 305 | 35 | 40 x 36 | 55 | 117.5 | 85 | 330 | 72.5 |
| 273 | 172.5 | 220 | 180 | 200 | | 330 | 400 | 520 | 890 | 273 | 820 | 581 | 780 | 420 | 305 | 35 | 40 x 36 | 55 | 117.5 | 85 | 330 | 72.5 |
| 323 | 172.5 | 220 | 220 | 200 | | 330 | 400 | 645 | 1180 | 323 | 850 | 868 | 780 | 540 | 400 | 35 | 40 x 36 | 55 | 117.5 | 85 | 330 | 72.5 |

* Full selection of lengths available, by multiples of 10 mm - In Schritten von 10 mm - Multiples de 10 mm - Multipli di 10 mm

**Valid for round inlet and outlet spouts. For square or rectangular inlets and outlets check in the TU-catalogue or contact our local sales office.

Gültig nur für runde Ein- und Ausläufe. Bei quadratischen oder rechteckigen Ein- und Ausläufen im TU-Katalog nachschlagen oder ein WAM® Verkaufsbüro kontaktieren.

Valide seulement pour des bouches rondes. Avec des bouches carrées ou rectangulaires consulter le catalogue TU ou contacter un des nos bureaux de vente.

Valido per bocche circolari. Per bocche quadrate o rettangolari consultare il ns catalogo tecnico TU o la ns rete vendita.

Solution F With Flange
 Version F mit Flansch
 Solution F avec bride
 Soluzione F con flangia

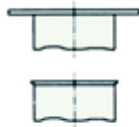

Inlet/Outlet
 Einlauf/Auslauf
 Bouche
 Bocca

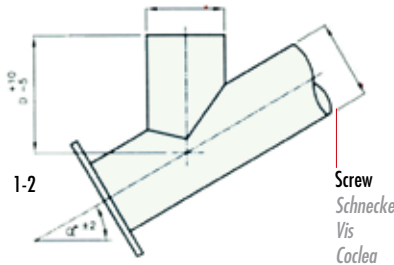

1 Round Inlet/Outlet
 Zylindrische Ein- und Ausläufe
 Bouches cylindriques
 Bocche cilindriche

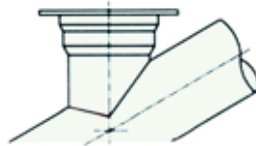

Inlet/Outlet
 Einlauf/Auslauf
 Bouche
 Bocca

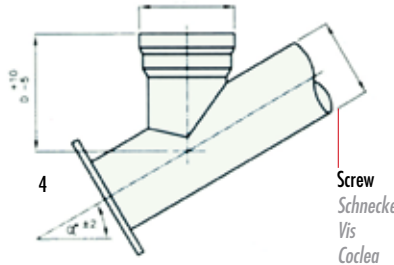

2 Tapered-Round Inlet/Outlet
 Konische Ein- und Ausläufe
 Bouches coniques cylindriques
 Bocche coniche cilindriche

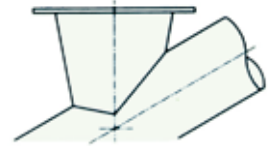

Inlet/Outlet
 Einlauf/Auslauf
 Bouche
 Bocca

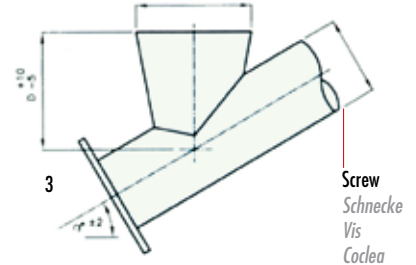

3 Tapered Inlet/Outlet
 Konische Ein- und Ausläufe
 Bouches coniques
 Bocche coniche

4 Beaded Inlet/Outlet
 Gebördelte Ein- u. Ausläufe
 Bouche bordées
 Bocche bordate

| Ø Screw Schnecke Vis Coclea | Ø Inlet/Outlet Ein-/Auslauf Bouches Bocche | * | Height "D" according to solution chosen - Höhe "D" abhängig von der gewählten Version - Hauteur "D" en fonction de la solution choisie - Altezza "D" in funzione della soluzione scelta. | | | | | | | | | | | | | | | | | | | | kg |
|---|--|---|--|-----|-----|-----|-----|-----|-----|-----|-----|-----|-----|-----|-----|-----|-----|-----|-----|-----|-----|-----|----|
| | | | 0° | | 5° | | 10° | | 15° | | 20° | | 25° | | 30° | | 35° | | 40° | | 45° | | |
| | | | F | T | F | T | F | T | F | T | F | T | F | T | F | T | F | T | F | T | F | T | |
| 114 | 114 | 1 | 120 | 120 | 120 | 120 | 120 | 120 | 120 | 120 | 120 | 120 | 120 | 120 | 120 | 120 | 120 | 120 | 120 | 120 | 120 | 120 | 2 |
| | 168 | 3 | 170 | 220 | 170 | 220 | 170 | 220 | 170 | 220 | 170 | 220 | 170 | 220 | 170 | 220 | 220 | 220 | 220 | 220 | 220 | 220 | 2 |
| | 193 | 3 | 245 | 295 | 245 | 295 | 245 | 295 | 245 | 295 | 245 | 295 | 245 | 295 | 245 | 295 | 245 | 295 | 245 | 295 | 245 | 295 | 3 |
| | 219 | 3 | 225 | 275 | 225 | 275 | 225 | 275 | 225 | 275 | 225 | 275 | 225 | 275 | 225 | 275 | 225 | 275 | 225 | 275 | 245 | 275 | 3 |
| 139 | 114 | 1 | 145 | 145 | 145 | 145 | 145 | 145 | 145 | 145 | 145 | 145 | 145 | 145 | 145 | 145 | 145 | 145 | 145 | 145 | 145 | 145 | 2 |
| | 168 | 4 | 210 | 210 | 210 | 210 | 210 | 210 | 210 | 210 | 210 | 210 | 210 | 210 | 210 | 210 | 210 | 210 | 210 | 210 | 210 | 210 | 3 |
| | 193 | 4 | 175 | 225 | 175 | 225 | 175 | 225 | 175 | 225 | 175 | 225 | 175 | 225 | 175 | 225 | 225 | 225 | 225 | 225 | 225 | 225 | 2 |
| | 219 | 3 | 250 | 300 | 250 | 300 | 250 | 300 | 250 | 300 | 250 | 300 | 250 | 300 | 250 | 300 | 250 | 300 | 300 | 300 | 300 | 300 | 3 |
| 168 | 168 | 1 | 175 | 175 | 175 | 175 | 175 | 175 | 175 | 175 | 175 | 175 | 175 | 175 | 175 | 175 | 175 | 175 | 175 | 175 | 175 | 175 | 3 |
| | 193 | 1 | 230 | 230 | 230 | 230 | 230 | 230 | 230 | 230 | 230 | 230 | 230 | 230 | 230 | 230 | 230 | 230 | 230 | 230 | 230 | 230 | 5 |
| | 219 | 4 | 230 | 230 | 230 | 230 | 230 | 230 | 230 | 230 | 230 | 230 | 230 | 230 | 230 | 230 | 230 | 230 | 230 | 230 | 230 | 230 | 8 |
| | 273 | 3 | 325 | 375 | 325 | 375 | 325 | 375 | 325 | 375 | 325 | 375 | 325 | 375 | 325 | 375 | 325 | 375 | 325 | 375 | 325 | 375 | 5 |
| 193 | 168 | 3 | 200 | 200 | 200 | 200 | 200 | 200 | 200 | 200 | 200 | 200 | 200 | 200 | 200 | 200 | 200 | 200 | 200 | 200 | 200 | 200 | 3 |
| | 183 | 1 | 175 | 175 | 175 | 175 | 175 | 175 | 175 | 175 | 175 | 175 | 175 | 175 | 175 | 175 | 175 | 175 | 175 | 175 | 175 | 175 | 5 |
| | 219 | 1 | 250 | 250 | 250 | 250 | 250 | 250 | 250 | 250 | 250 | 250 | 250 | 250 | 250 | 250 | 250 | 250 | 250 | 250 | 250 | 250 | 8 |
| | 273 | 4 | 250 | 300 | 250 | 300 | 250 | 300 | 250 | 300 | 250 | 300 | 250 | 300 | 250 | 300 | 250 | 300 | 300 | 300 | 300 | 300 | 5 |
| 219 | 323 | 3 | 290 | 340 | 290 | 340 | 290 | 340 | 290 | 340 | 290 | 340 | 290 | 340 | 290 | 340 | 290 | 340 | 340 | 340 | 340 | 340 | 7 |
| | 193 | 1 | 205 | 205 | 205 | 205 | 205 | 205 | 205 | 205 | 205 | 205 | 205 | 205 | 205 | 205 | 205 | 205 | 205 | 205 | 205 | 205 | 5 |
| | 219 | 1 | 205 | 205 | 205 | 205 | 205 | 205 | 205 | 205 | 205 | 205 | 205 | 205 | 205 | 205 | 205 | 205 | 205 | 205 | 205 | 205 | 8 |
| | 273 | 4 | 280 | 280 | 280 | 280 | 280 | 280 | 280 | 280 | 280 | 280 | 280 | 280 | 280 | 280 | 280 | 280 | 280 | 280 | 280 | 280 | 10 |
| 273 | 323 | 3 | 320 | 370 | 320 | 370 | 320 | 370 | 320 | 370 | 320 | 370 | 320 | 370 | 320 | 370 | 320 | 370 | 370 | 370 | 370 | 370 | 7 |
| | 219 | 1 | 260 | 260 | 260 | 260 | 260 | 260 | 260 | 260 | 260 | 260 | 260 | 260 | 260 | 260 | 260 | 260 | 260 | 260 | 260 | 260 | 8 |
| | 273 | 1 | 250 | 250 | 250 | 250 | 250 | 250 | 250 | 250 | 250 | 250 | 250 | 250 | 250 | 250 | 250 | 250 | 250 | 250 | 250 | 250 | 10 |
| | 323 | 4 | 315 | 315 | 315 | 315 | 315 | 315 | 315 | 315 | 315 | 315 | 315 | 315 | 315 | 315 | 315 | 315 | 315 | 315 | 315 | 315 | 13 |
| 323 | 356 | 3 | 300 | 300 | 300 | 300 | 300 | 300 | 300 | 300 | 300 | 300 | 300 | 300 | 300 | 300 | 300 | 300 | 300 | 300 | 300 | 300 | 7 |
| | 273 | 1 | 260 | 260 | 260 | 260 | 260 | 260 | 260 | 260 | 260 | 260 | 260 | 260 | 260 | 260 | 260 | 260 | 260 | 260 | 260 | 260 | 10 |
| | 323 | 1 | 300 | 300 | 300 | 300 | 300 | 300 | 300 | 300 | 300 | 300 | 300 | 300 | 300 | 300 | 300 | 300 | 300 | 300 | 300 | 300 | 13 |
| | 356 | 3 | 310 | 310 | 310 | 310 | 310 | 310 | 310 | 310 | 310 | 310 | 310 | 310 | 310 | 310 | 310 | 310 | 310 | 310 | 310 | 310 | 17 |

Beaded edges and flanges to be ordered as accessories
 Bördel und Flansche als Zubehör bestellen
 Joncs et brides commander comme accessoires
 Bordino e flangia vanno ordinati come accessori

- For flange selection see catalogue
- Flansche siehe Katalog
- Pour brides voir tableau dans le catalogue
- Per scelta flange vedi catal. specifico

- Standard diameter unless specified otherwise
- Standarddurchmesser, wenn nicht anders spezifiziert
- Diamètre standard si ne pas spécifié
- Diametro standard quando non specificato

Available from:
FILQUIP Pty Limited

5/126 Compton Rd, Underwood,
Qld 4119 Australia
Ph: +61 7 3208 3499 Fx: +61 7 3208 3449
Email: sales@filquip.com.au
www.filquip.com.au



WAM S.p.A.
Via Cavour, 338
I - 41030 Ponte Motta
Cavezzo (MO) - ITALY

Tel: +39 / 0535 / 61 81 11
Fax: +39 / 0535 / 61 82 26

info@wamgroup.com
www.wamgroup.com

Further Products - Weitere Produkte - Autre production - Altra produzione

